

Article number: 20414188A

Description: E+G Safety indexing plungers

GN 414.1-8-8-A with safety mechanism, without rest position, without lock nut

Measures

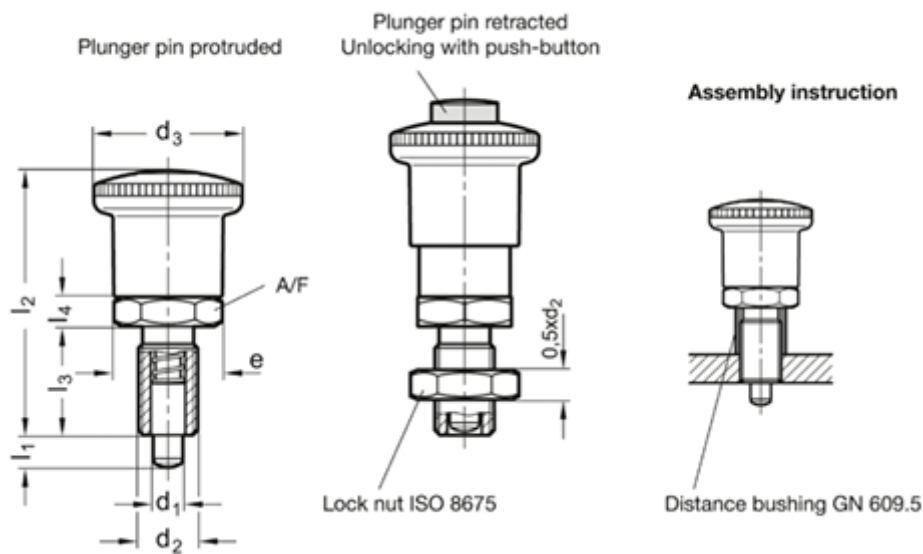

A/F	= 26
d1 Pin -0.02/-0.04 Bore H7	= 8
d2	= M 16 x 1.5
d3	= 30
e	= 21.9
l3	= 26
l4	= 8
l1 min.	= 8

l2 ?	= 59.5
Weight in (g)	= 74